

Since 1910

DANUSER

Machine Company, Inc.

5-Year Warranty

The original yellow.

500 E. Third Street
P.O. Box 368
Fulton, MO 65251

TEL: (573) 642-2246
FAX: (573) 642-2240
E-MAIL: sales@danuser.com

www.danuser.com



Manufactured,
not just assembled,
in the U.S.A.

Experience

- ◆ Danuser is the leader with over 60 years of digging equipment design and manufacturing.

Quality & Reliability

- ◆ All gearboxes are backed by a 5-year warranty - the industry's best warranty with American components.

Performance Driven

- ◆ "Good enough won't do, it must be right!" K.B. Danuser We stake our name and reputation on it.

The Benchmark

- ◆ Danuser Diggers outperform and outlast the competition.

Solid Future

- ◆ Family-Owned,
4th Generation

Contact Danuser - we make your "hole" job easier!

Since 1910

DANUSER

DIGGERS & AUGERS

Made in the U.S.A.

Since 1910, Danuser has been known for quality and innovation. Today, the same quality and innovation are brought to market with pride by the fourth generation of Danusers.

We offer a complete line of top quality hydraulic and PTO diggers, augers, and accessories.

Danuser equipment is American made from high quality materials that are precision machined and assembled in our Fulton, Missouri plant. Our diggers stand the ultimate test on your farm, construction site, rental yard, or landscaping business. Our Serial # 2, a F-Series Digger built in 1943, is still in service.

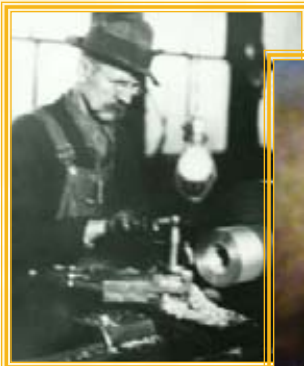

K.B. Danuser



Henry Danuser

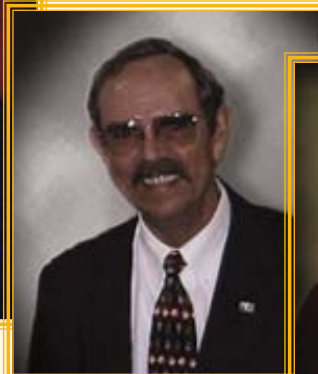

Jerry Danuser

Family-Owned,
4th Generation!



Janea & Glenn Danuser

OUR FAMILY CARES ABOUT THE SAFETY OF YOURS!

Danuser PTO Diggers come with three (3) different guards. They are available for the thousands of Danuser Diggers that are working today, regardless of their age. Make sure your unit has them. If you do not have current safety guarding, contact your local dealer or Danuser Machine Company, Inc.

We urge all owners to have an Auger Adapter Guard, fully guarded driveline, and Pinion Guard installed. Together they will serve as some protection against misuse. However, they in no way nullify the clearly stated safety messages in the Owner's Manual. Other than the operator on the tractor, no one should be within twenty-five feet (25') of a digger under power.

- ◆ Danuser Diggers are designed for one-person operation from the tractor seat.
- ◆ Read and fully understand the Owner's Manual. For anyone using the machine who does not read or understand English, it is your responsibility to translate or provide an interpreter.
- ◆ Never pull down on the gear housing for extra digging power. A Down Force Kit is available that provides five hundred pounds (500 lbs.) of additional down pressure to the auger point.
- ◆ Never replace any part that is not factory approved, and never alter or attach items that were not furnished or recommended for safety retrofitting by Danuser.

NEVER IGNORE COMMON SENSE RULES OF SAFETY!

SAFE AND SENSIBLE OPERATION OF YOUR DANUSER DIGGER IS YOUR RESPONSIBILITY. PLEASE TAKE IT SERIOUSLY!

HOW TO CHOOSE THE RIGHT DANUSER DIGGER FOR YOU

PTO DIGGERS

1. What is the PTO horsepower (HP) of your tractor?
2. Does your tractor have an ASAE Category I or II 3-pt. hitch?
3. What is the biggest diameter auger you would ever use?

MODEL OUTPUT SPINDLE	PTO HORSEPOWER (HP)	ASAE CATEGORY 3-PT. HITCH	MAXIMUM DIAMETER AUGER
G20/40 2" round	20 to 40	I	24"
J20/80 2" round	20 to 80	I or II	24"
F8 2-9/16" round	40 and above	I or II	30"

HYDRAULIC DIGGERS

1. Choose a mounting option: front-end loader mount, skid-steer mount, or ASAE Category I or II 3-pt. hitch mount.
2. What is your gallons per minute (GPM) flow of hydraulic oil?
3. What is the pressure (PSI) of your hydraulic system?
4. What is the biggest diameter auger you would ever use?

MODEL OUTPUT SPINDLE	MOUNTING OPTION	GALLONS PER MINUTE (GPM)	PRESSURE (PSI)	MAX. DIAMETER AUGER
8300-1 2" round	Bolts on side or bottom of front-end loader bucket	5-10	1500-3000	14"
8300-2 2" round	Bolts on side or bottom of front-end loader bucket	10-20	1500-3000	24"
8800-1 2" round	ASAE Category I 3-pt. hitch	5-10	1500-3000	14"
8800-2 2" round	ASAE Category I 3-pt. hitch	10-20	1500-3000	24"
8900-4 2-9/16" round	Front-end loader, skid-steer, or ASAE Cat. I or II 3-pt. hitch	10-20	1500-3000	36"
8900-7 2-9/16" round 8900-8 2" hex	Front-end loader, skid-steer, or ASAE Cat. I or II 3-pt. hitch	14-30	1500-3000	36"

DANUSER AUGERS

Choose plain, serrated, or Hole Digger Head Augers (pages 8 and 9) to fit your digging application. The correct cutting edges or teeth will make a significant difference on how the auger will penetrate the ground.

MODEL G20/40

MODEL G20/40

- ◆ Category I 3-pt. hitch mount with 3" O.D. boom and yoke
- ◆ Rated for 20-40 HP tractors
- ◆ Gearbox ratio of 3.1:1
- ◆ Delivers 1,014 ft.-lbs. of torque
- ◆ Straight bevel ring gear and pinion are mounted in Timken tapered roller bearings
- ◆ 2" round output spindle
- ◆ 24" maximum diameter auger
- ◆ Completely guarded PTO driveline
- ◆ Auger Adapter Guard and Pinion Guard
- ◆ 5-year warranty (gearbox)



G20/40 & J20/80 gearbox cut-away with one quarter of Auger Adapter Guard removed



MODEL J20/80



MODEL J20/80

- ◆ Category I or II 3-pt. hitch mount with 3-1/2" O.D. boom and 3" O.D. yoke
- ◆ Rated for 20-80 HP tractors
- ◆ Gearbox ratio of 3.1:1
- ◆ Delivers 1,014 ft.-lbs. of torque
- ◆ Straight bevel ring gear and pinion are mounted in Timken tapered roller bearings
- ◆ 2" round output spindle
- ◆ 24" maximum diameter auger
- ◆ Completely guarded PTO driveline
- ◆ Auger Adapter Guard and Pinion Guard
- ◆ 5-year warranty (gearbox)

MODEL F8



Model F8 shown on Auger Cart

The F-Series Digger has been digging holes since 1943.

F8 gearbox cut-away with half of Auger Adapter Guard removed

MODEL F8

- ◆ Category I or II 3-pt. hitch mount with 3-1/2" O.D. boom and 3" O.D. yoke
- ◆ Rated for 40 HP and above tractors
- ◆ Gearbox ratio of 4.125:1
- ◆ Delivers 1,813 ft.-lbs. of torque
- ◆ Spiral bevel ring gear and pinion are mounted in Timken tapered roller bearings
- ◆ 2-9/16" round output spindle
- ◆ 30" maximum diameter auger
- ◆ Completely guarded PTO driveline
- ◆ Auger Adapter Guard and Pinion Guard
- ◆ 5-year warranty (gearbox)

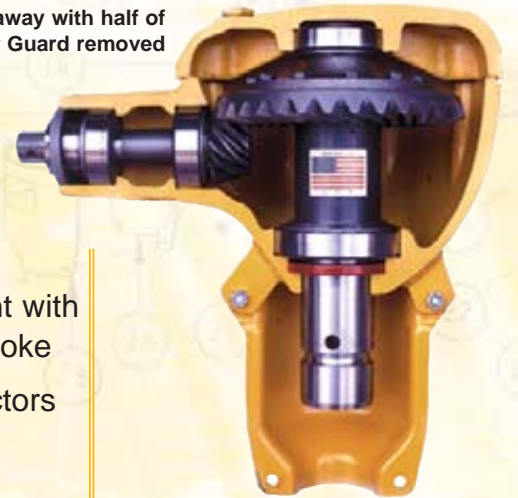

MODEL 8300



MODEL 8300

- ◆ Front-end loader mount attaches to side or bottom of bucket
- ◆ 8300-1 - 5-10 GPM at 1500-3000 PSI
8300-2 - 10-20 GPM at 1500-3000 PSI
- ◆ Gearbox ratio of 3.1:1
- ◆ Eaton high torque, fully reversible hydraulic motor
- ◆ Timken tapered roller bearings
- ◆ Dual-lip, spring-loaded seals
- ◆ 2" round output spindle
- ◆ 14" maximum diameter auger for 8300-1 and 24" for 8300-2
- ◆ Auger Adapter Guard
- ◆ 5-year warranty (gearbox)

MODEL 8800

MODEL 8800

- ◆ Category I 3-pt. hitch mount with 3" O.D. boom and yoke
- ◆ 8800-1 - 5-10 GPM at 1500-3000 PSI
8800-2 - 10-20 GPM at 1500-3000 PSI
- ◆ Gearbox ratio of 3.1:1
- ◆ Eaton high torque, fully reversible hydraulic motor
- ◆ Timken tapered roller bearings
- ◆ Dual-lip, spring-loaded seals
- ◆ 2" round output spindle
- ◆ 14" maximum diameter auger for 8800-1 and 24" for 8800-2
- ◆ Auger Adapter Guard
- ◆ 5-year warranty (gearbox)



MODEL 8900



MODEL 8900

- ◆ Mounts: Skid-Steer Quick Attach, Front-End Loader, or Category I or II 3-pt. hitch
- ◆ 8900-4 - 10-20 GPM at 1500-3000 PSI
8900-7 - 14-30 GPM at 1500-3000 PSI
8900-8 Hex - 14-30 GPM at 1500-3000 PSI
- ◆ Planetary gearbox ratio of 4.08:1
- ◆ Eaton high torque, fully reversible hydraulic motor and Auburn planetary gearbox
- ◆ 8900-4 & -7 have 2-9/16" round output spindle
8900-8 has 2" hex output spindle
- ◆ 36" maximum diameter auger
- ◆ Auger Adapter Guard
- ◆ 5-year warranty (gearbox)



TORQUE (FT.-LBS.) - THEORETICAL VALUES

MODEL	1500 PSI	2000 PSI	2250 PSI	2500 PSI	2750 PSI	3000 PSI
8300-1 & 8800-1	492	656	738	820	902	984
8300-2 & 8800-2	732	976	1098	1220	1342	1464
8900-4	966	1288	1449	1610	1771	1932
8900-7 & -8	1518	2024	2277	2530	2783	3036

SPEED (RPM) - THEORETICAL VALUES

MODEL	5 GPM	6 GPM	8 GPM	10 GPM	12 GPM	14 GPM	16 GPM	18 GPM	19 GPM	20 GPM	25 GPM	30 GPM
8300-1 & 8800-1	47	56	75	93								
8300-2 & 8800-2				63	75	88	100	113	119	126		
8900-4				48	57	67	76	86	90	95		
8900-7 & -8						42	48	54	58	61	76	91

EDGES & TEETH

Cutting edges are available in plain or serrated. The Hole Digger Head uses teeth. Each cutting edge and tooth is manufactured from alloy steel and heat treated for maximum durability. Both cutting edges and teeth are replaceable.

PLAIN



SERRATED



HOLE DIGGER HEAD

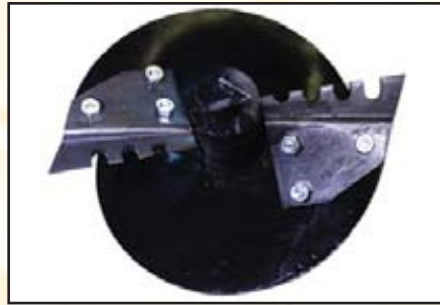
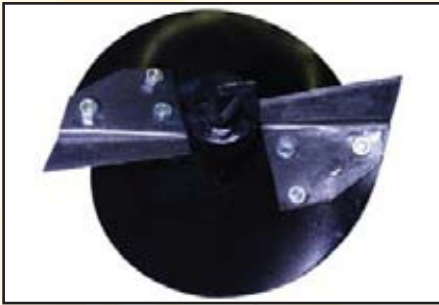

- ◆ Sharp Edge Design
- ◆ Normal Digging Conditions

- ◆ Serrated to Tear Through Compacted Soils and Light Tree Roots

- ◆ Most Aggressive Design Rips Through Clay, Caliche, Shale, Mixed Limestone, Frozen Ground, and Light Rock
- ◆ Hard-Surface Teeth Recommended for Increased Productivity and Longevity

HOLE DIGGER HEAD FIELD WELD KIT

- ◆ Field Weld Kit Available to Transform Plain or Serrated Edge Augers to Hole Digger Head Augers



AUGER POINTS

Replaceable auger points are available in standard duty, special duty, and aggressive duty for different applications. Each point is manufactured from alloy steel and heat treated for maximum durability.

Standard Duty Point for 4" Diameter Augers



- ◆ Standard with 4" Dia. Augers
- ◆ Dirt Digging

Standard Duty Point



- ◆ Standard with Augers
- ◆ Dirt Digging

Special Duty Point



- ◆ Designed for Material to be Pushed Away to Allow Cutting Edges to Cut Into the Soil

Aggressive Duty Point



- ◆ Designed to Guide and Draw Auger Through the Ground in Dry or Compacted Soil

Hole Digger Head Special Duty Point



- ◆ For Hole Digger Head Augers
- ◆ Larger Thread Diameter

DANUSER AUGERS

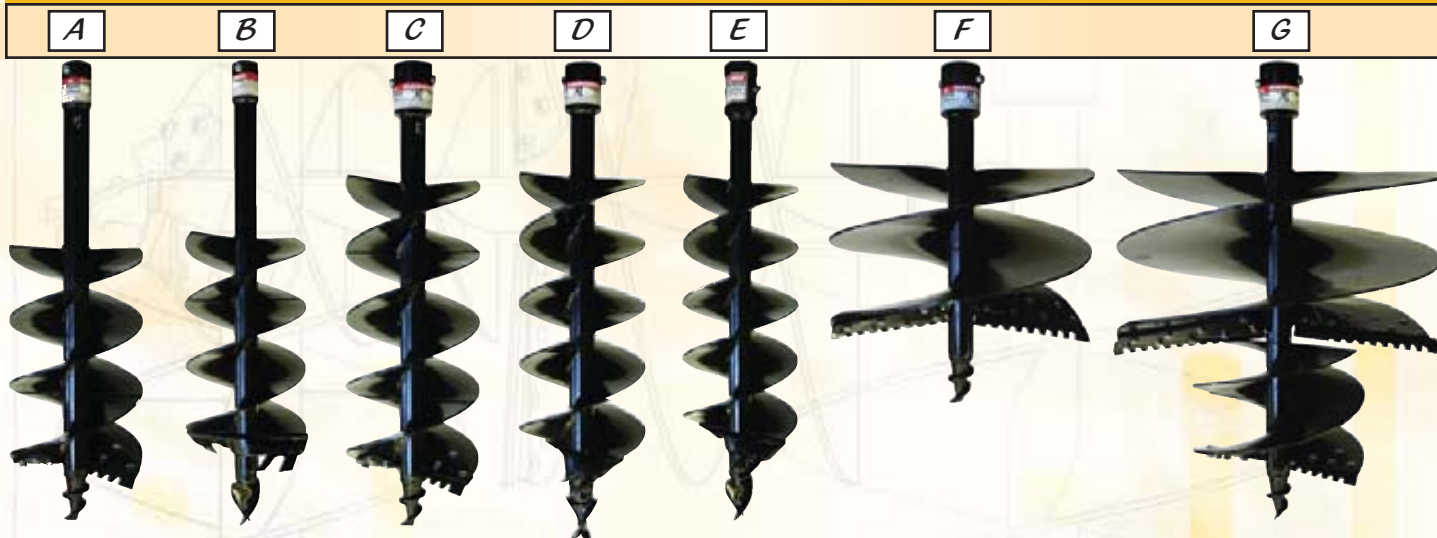

A. 2" Round Plain and Serrated Augers, 4", 6", 9", 12", 14", 16", 18", 24" Dia., Double Flighting, 40" Standard Length

B. 2" Round Hole Digger Head Augers, 6", 9", 12", 14", 16" Dia., Double Flighting, 40" Standard Length

C. 2-9/16" Round Plain and Serrated Augers, 4", 6", 9", 10", 12", 14", 16", 18", 24", 30", 36" Dia., Double Flighting, 40" Standard Length - 52" & 72" Lengths Available

D. 2-9/16" Round Hole Digger Head Augers, 6", 9", 10", 12", 14", 16", 18", 24", 30", 36" Dia., Single & Double Flighting, 40" Standard Length - 52" & 72" Lengths Available

E. 2" Hex Hole Digger Head Augers, 6", 9", 10", 12", 14", 16", 18", 24", 30", 36" Dia., Single & Double Flighting, 40" Standard Length - 52" & 72" Lengths Available

F. 2" or 2-9/16" Round Serrated Orchard Augers, 18" or 24" Dia., Double Flighting, 29" Standard Length

G. 2" or 2-9/16" Round Plain or Serrated Stepped Tree Planting Augers, Double Flighting, 18" x 10" Dia., 33" Standard Length, 24" x 12" Dia. & 30" x 16" Dia., 40" Standard Length

AUGER ADAPTER GUARDS

Danuser Auger Adapter Guards are standard equipment with all Danuser Diggers. They provide protection from bolt entanglement accidents.



AUGER EXTENSIONS WITH GUARDS

Dig deeper holes by adding auger extensions to your auger. All Danuser Auger Extensions come with an Auger Extension Guard. If you have an auger extension without a guard, we strongly recommend you obtain one.



**RETROFIT SAFETY GUARDING for all older Danuser models is available factory direct!
Older machines should not be operated without current safety guarding installed!**

DANUSER AUGER CART

U.S. Patent No.: 6,419,245 B1



Use In Four Easy Steps!



Step 1:
Move the Auger Cart into position and slowly lower the auger point into the auger point holder.

Step 2:
Attach the four ratchet straps, and disconnect the driveline or hydraulic hoses. Support the digger yoke with the yoke support assembly.



Step 3:
Disconnect the digger from the tractor 3-pt. hitch.

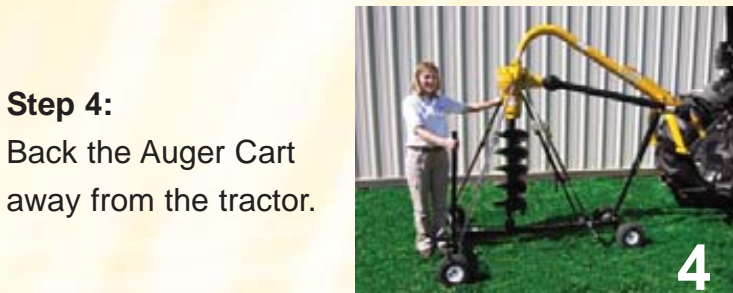

Step 4:
Back the Auger Cart away from the tractor.



Auger Cart Shown with Model F8 Digger

AUGER CART

- ◆ One-person operation
- ◆ 24" maximum auger diameter
- ◆ Use on any level surface
- ◆ Parking brake
- ◆ 4 wheels and steering capabilities

Quickly and easily attach or detach, transport, and store Danuser 3-pt. Hitch Diggers: F8, J20/80, G20/40, 8800, and 8900.

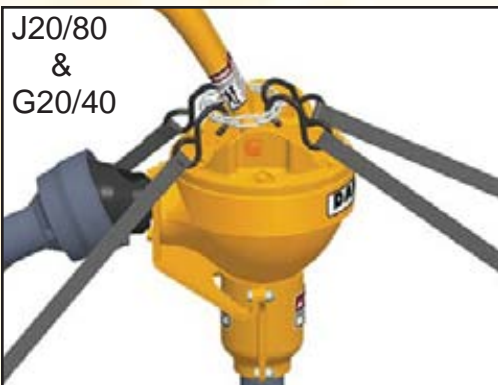

DOWN FORCE KITS



Down force kits are available to make difficult digging easier. The kits attach to all Danuser boom-type diggers without alteration and with the use of ordinary hand tools. They provide approximately 500 pounds of additional force to the auger point for easier penetration of hard or frozen ground.

Kits do not interfere with normal digging operations.

NOTE: Kits operate with a one-way hydraulic cylinder. One line is connected to a tractor remote outlet and a second non-pressure line connected to the hydraulic system sump.



Models F8 & 8900
Down Force Kit

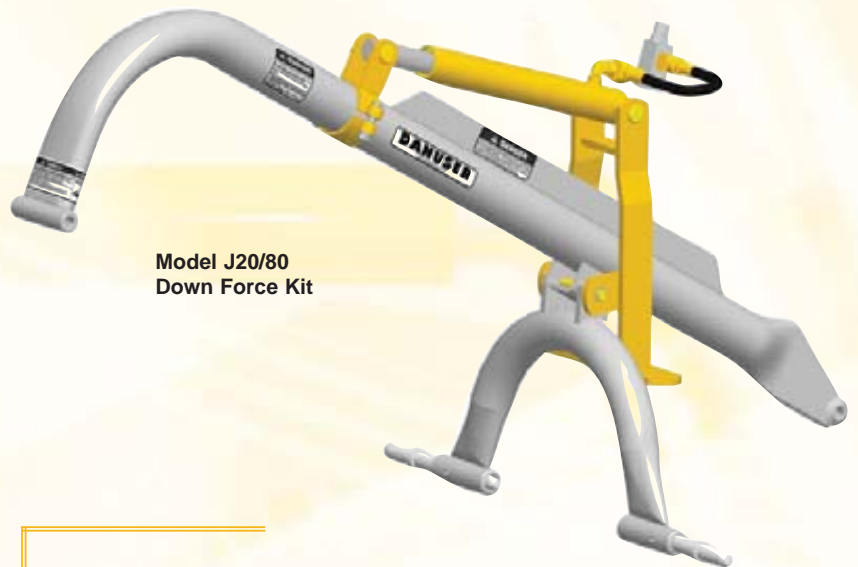

Model J20/80
Down Force Kit



Models G20/40 & 8800
Down Force Kit

Make difficult digging easier!

All dimensions given in inches.

DANUSER

DIGGERS AT A GLANCE

PTO MODELS	G20/40	J20/80	F8
MOUNTING	ASAE Category I 3-pt. hitch 20-40 HP tractors	ASAE Category I or II 3-pt. hitch 20-80 HP tractors	ASAE Category I or II 3-pt. hitch 40 HP & above tractors
COMPONENTS			
Gear Set / Ratio	straight bevel 3.1:1	straight bevel 3.1:1	spiral bevel 4.125:1
Driveline (fully guarded)	540 RPM Weasler driveline	540 RPM Weasler driveline	540 RPM Weasler driveline
Bearings	Timken tapered roller	Timken tapered roller	Timken tapered roller
Seals	dual-lip, spring-loaded	dual-lip, spring-loaded	dual-lip, spring-loaded
Boom (with reinforcing rib)	3" O.D. tubing	3-1/2" O.D. tubing	3-1/2" O.D. tubing
Yoke	3" O.D. tubing with Category I pins	3" O.D. tubing with Category I or II pins	3" O.D. tubing with Category I or II pins
Output Spindle Size	2" round	2" round	2-9/16" round
AUGERS			
Diameters	4, 6, 9, 12, 14, 16, 18, 24	4, 6, 9, 12, 14, 16, 18, 24	4, 6, 9, 10, 12, 14, 16, 18, 24, 30
Flighting	double (replaceable)	double (replaceable)	double or single (replaceable)
Depths	29, 33, 40	29, 33, 40	29, 33, 40, 52
Extensions	7, 14	7, 14, 21	7, 14, 21
Points	std., special, & aggressive duty	std., special, & aggressive duty	std., special, & aggressive duty
Cutting Edges	plain, serrated, & Hole Digger Head	plain, serrated, & Hole Digger Head	plain, serrated, & Hole Digger Head
WARRANTY (gearbox)	5 years	5 years	5 years

HYDRAULIC MODELS	8300	8800	8900
MOUNTING	front-end loader bucket	ASAE Category I 3-pt. hitch tractors	skid-steer, front-end loader, or ASAE Category I or II 3-pt. hitch tractors
HYDRAULIC REQUIREMENTS	8300-1 - 5-10 GPM 8300-2 - 10-20 GPM 1500-3000 PSI	8800-1 - 5-10 GPM 8800-2 - 10-20 GPM 1500-3000 PSI	8900-4 - 10-20 GPM 8900-7 - 14-30 GPM 8900-8 hex - 14-30 GPM 1500-3000 PSI
MAXIMUM DIAMETER AUGER	8300-1 - 14" 8300-2 - 24"	8800-1 - 14" 8800-2 - 24"	36"
COMPONENTS			
Motor (fully reversible)	Eaton high torque hydraulic	Eaton high torque hydraulic	Eaton high torque hydraulic
Gear Set / Ratio	straight bevel 3.1:1	straight bevel 3.1:1	planetary 4.08:1
Bearings	Timken tapered roller	Timken tapered roller	Timken tapered roller
Seals	dual-lip, spring-loaded	dual-lip, spring-loaded	dual-lip, spring-loaded
Boom (with reinforcing rib)	N/A	3" O.D. tubing	3-1/2" O.D. tubing
Yoke	N/A	3" O.D. tubing with Category I pins	3" O.D. tubing with Category I or II pins
Output Spindle Size	2" round	2" round	8900-4 & -7 - 2-9/16" round 8900-8 - 2" hex
AUGERS			
Diameters	4, 6, 9, 12, 14, 16, 18, 24	4, 6, 9, 12, 14, 16, 18, 24	4, 6, 9, 10, 12, 14, 16, 18, 24, 30, 36
Flighting	double (replaceable)	double (replaceable)	double or single (replaceable)
Depths	29, 33, 40	29, 33, 40	29, 33, 40, 52, 72
Extensions	7, 14, 21	7, 14	7, 14, 21, 48, 56, 72
Points	standard, special, & aggressive duty	standard, special, & aggressive duty	standard, special, & aggressive duty
Cutting Edges	plain, serrated, & Hole Digger Head	plain, serrated, & Hole Digger Head	plain, serrated, & Hole Digger Head
WARRANTY (gearbox)	5 years	5 years	5 years

**Contact Your Local Dealer
For More Information**

DANUSER MACHINE COMPANY, INC.
500 E. Third Street
P.O. Box 368
Fulton, MO 65251
TEL: (573) 642-2246
FAX: (573) 642-2240
E-MAIL: sales@danuser.com

www.danuser.com