



**Mod. NEXT SP.
Mod. NEXT AVANT**

**TRINCIA - BROYEUR - SHREDDER
HÄCKSLER - DESBROZADORA - ИЗМЕЛЬЧИТЕЛЬ**



Per la trinciatura di erba, residui di potature medio-leggere, residui vegetali in generale



Pour le broyage des herbes, sarments légers-moyennes, résidus végétaux en general



For the chopping of grass, light-medium prunings, vegetal residuals in general



Für das Häckseln von Gras/Weideflächen, leicht oder mittel Baumschnitte, Pflanzenresten im Allgemein



Para trinchar hierbas, residuos de poda medio-ligeros, restos vegetales en general



Для измельчения травы, остатков срезанных веток средне-легких, растительных остатков





NEXT SP. NEXT AVANT										
	Kg.	LBS	A mm.	B mm.	A inches	B inches	N.	HP	PTO	N.
1350	390	860	1382	1555	54,40	61,22	18	40 - 60	540 (1000)	3
1500	415	914	1524	1697	60,00	66,81	20	40 - 60	540 (1000)	3
1800	458	1010	1808	1981	71,18	77,99	24	40 - 60	540 (1000)	3
2100	509	1123	2092	2265	82,36	89,17	28	40 - 60	540 (1000)	4

(A)



- Rullo posteriore
- Controcotello
- Spostamento idraulico mm 400
- Perni filettati con dado (A)

- Rouleau arrière
- Contre couteau
- Déportable hydraulique mm 400
- Axes filetés avec écrou (A)

- Rear roller
- Counter blade
- Hydraulic offset mm 400
- Axles with nut (A)

- Hinterer Walze
- Gegenmesser
- Hydraulische Verschiebung mm 400
- Gewindebolzen mit Muttern (A)

- Rodillo posterior
- Contracuchillaatornillada
- Movimiento hidráulico mm 400
- Pernos roscado con tuerca (A)

- Заднегокатка
- Контрлезвие
- Гидравлическое смещение 400 мм
- Штыри с резьбой с гайкой (A)

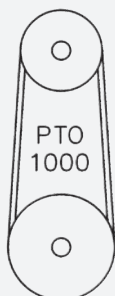
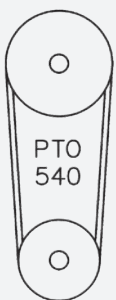







- Invertendo la posizione delle pulegge si passa da PTO 540 a PTO 1000
- Inversant la position des poulies on passe de PDF 540 à PDF 1000
- Inverting the position of the pulleys you change from PTO 540 to PTO 1000
- Um die Umdrehung von 540 bis 1000 zu wechseln, muss man die Riemenscheiben vertauschen
- Invertiendo la posición de las poleas, se pasa de TDF 540 a TDF 1000
- Инверсия положение шкивов переходе от BOM 540 BOM 1000

Mod. NEXT AVANT

 40-60 HP







FALC

-  **ABBINABILE ANTERIORMENTE E POSTERIORMENTE AL TRATTORE**
-  **IL PEUT ETRE MONTÉ À L'AVANT OU A L'ARRIÈRE DU TRACTEUR**
-  **IT CAN BE FITTED BOTH IN THE FRONT AND BACK OF THE TRACTOR**
-  **FÜR FRONT UND HECKANBAU**
-  **ACOPLABLE AL TRACTOR ANTERIORMENTE Y POSTERIORMENTE**
-  **МОЖНО ПОДСОЕДИНИТЬ СПЕРЕДИ ИЛИ СЗАДИ ТРАКТОРА**



 **OPZIONE**  **OPTION**  **OPTION**  **OPTION**  **OPCIÓN**  **ОПЦИЯ**



-  **CON ATTACCO A 3 PUNTI DOPPIO**
-  **AVEC ATTELAGE 3 POINTS DOUBLE**
-  **WITH DOUBLE 3 POINT HITCH**
-  **MIT DOPPEL 3-PUNKT- ANHÄNGUNG**
-  **CON DOBLE ENGANCHE DE TRES PUNTOS**
-  **С ДВОЙНОЙ ТРЕХТОЧЕЧНОЙ НАВЕСКОЙ**

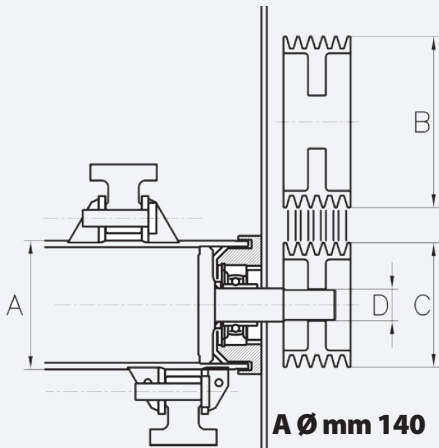

A Ø mm 140
B Ø mm 250
C Ø mm 180
D Ø mm 40

A Ø inches 5,51
B Ø inches 9,84
C Ø inches 7,09
D Ø inches 1,57

NEXT SP / AVANT	mm		inches	
	780	602	30,71	23,70
1350	380	1002	14,96	39,45
1500	380	1144	14,96	45,04
1800	380	1428	14,96	56,22
2100	380	1712	14,96	67,40

OPZIONE OPTION OPTION OPTION ORCIÓN ОПЦИЯ

COPPIA RUOTE ANTERIORI IN FERRO Ø 190

COUPLE DE ROUES ANTÉRIEURES EN FER Ø 190

PAIR OF FRONT IRON SUPPORTING WHEELS Ø 190

PAAR VORDERRÄDER AUS EISEN Ø 190

PAR DE RUEDAS ANTERIORES EN HIERRO Ø 190

ПАРА ПЕРЕДНИХ МЕТАЛИЧЕСКИХ КОЛЕС Ø 190



COPPIA SLITTE FISSE

COUPLE PATINS FIXES

PAIR OF FIX SKIDS

PAAR FESTE KUFEN

PAR PATINES FIJOS

ПАРА ФИКСИРОВАННЫХ ЛЫЖ



Via Proventa, 41
48018 Faenza (Italia)
Tel. +39 0546 29050
Fax +39 0546 663986

www.falc.eu | info@falc.eu